

10.1a

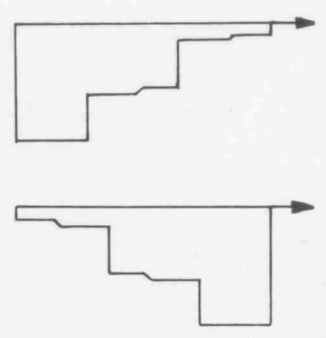

10. 1b

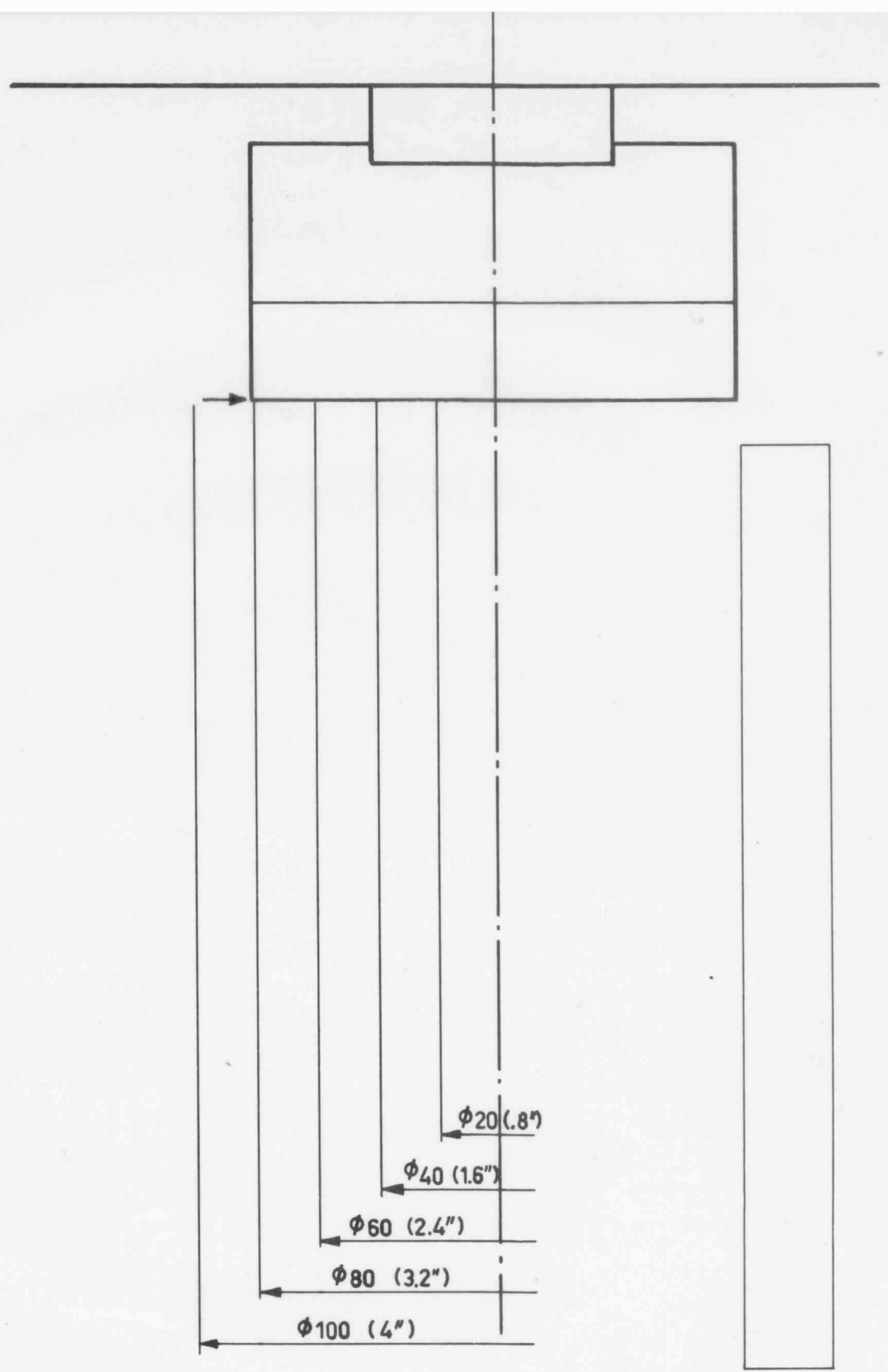

12 mm



10 mm



8 mm



5 mm



2 mm

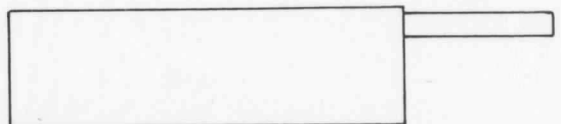
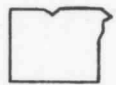
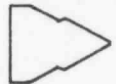
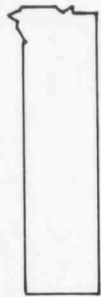

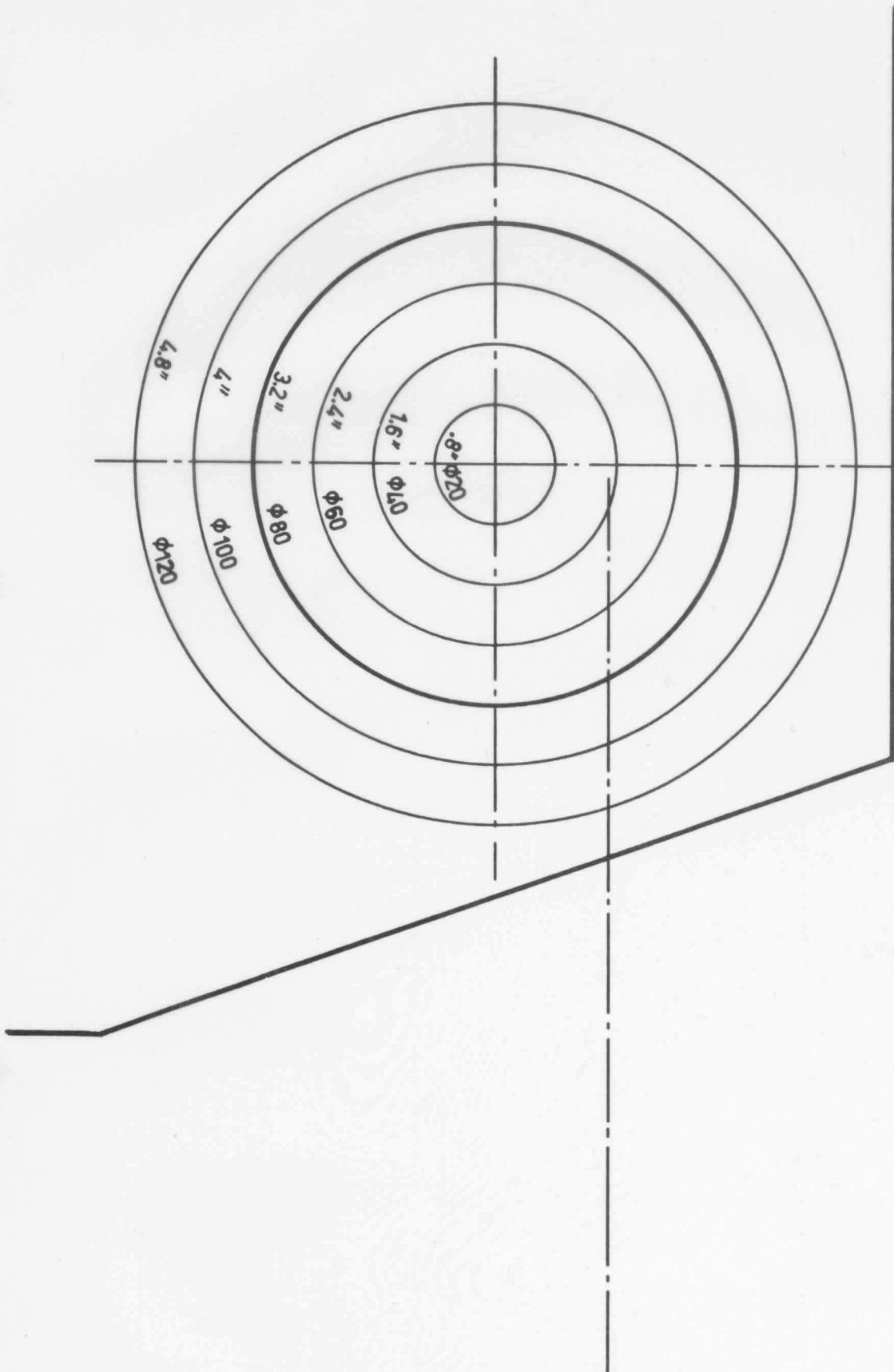

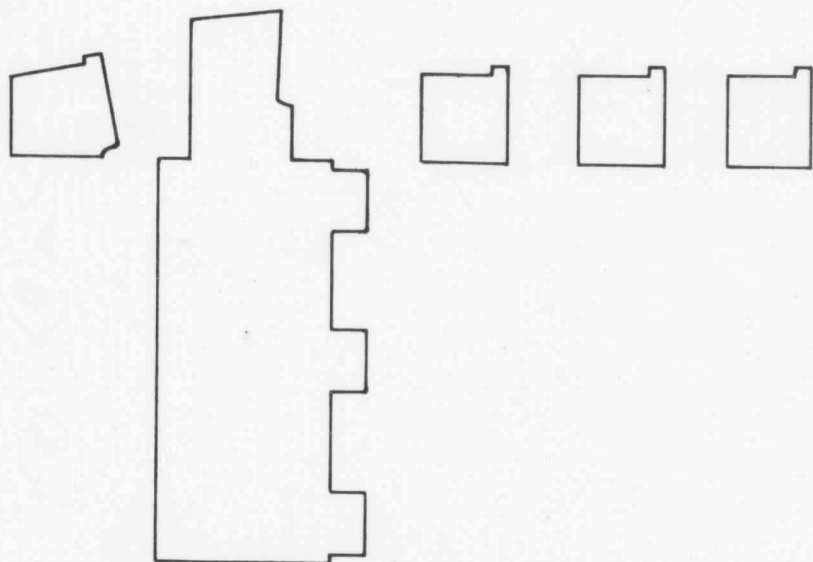
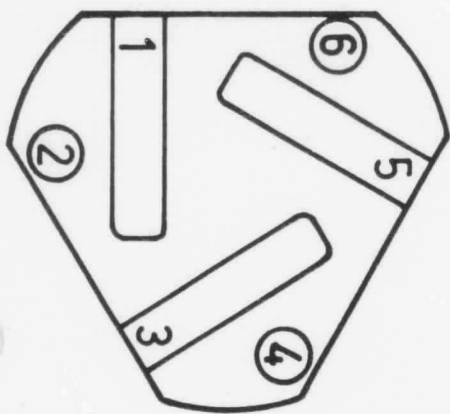
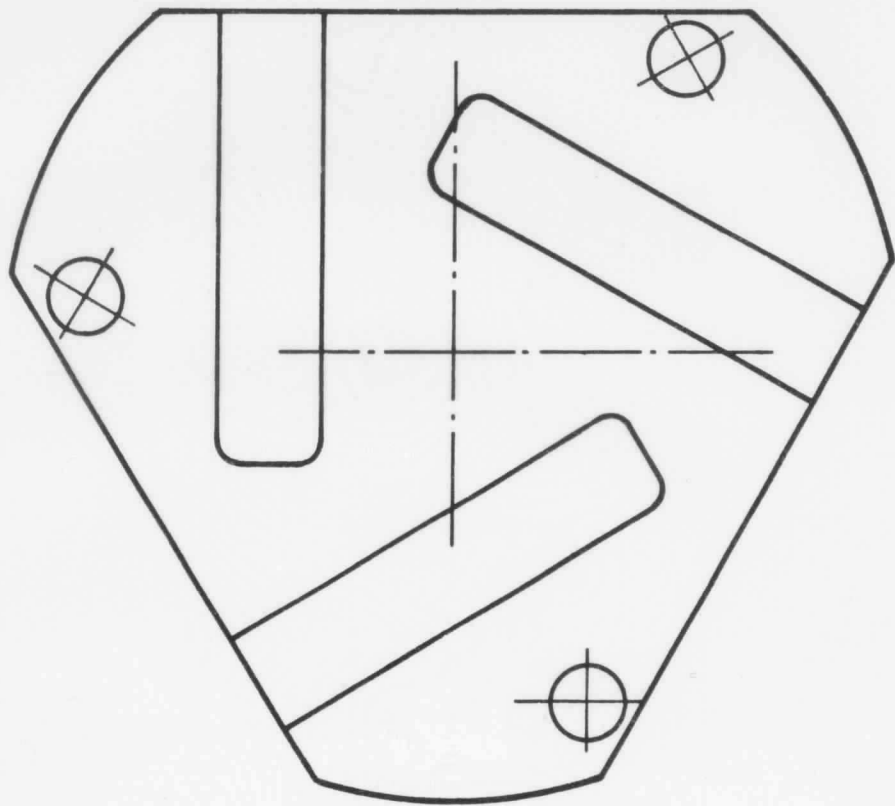

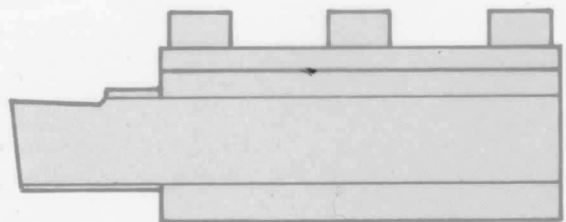
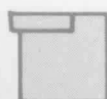
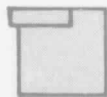
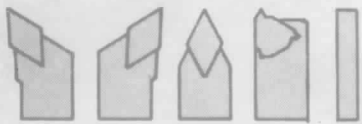
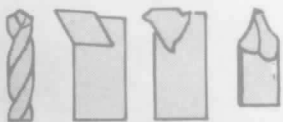
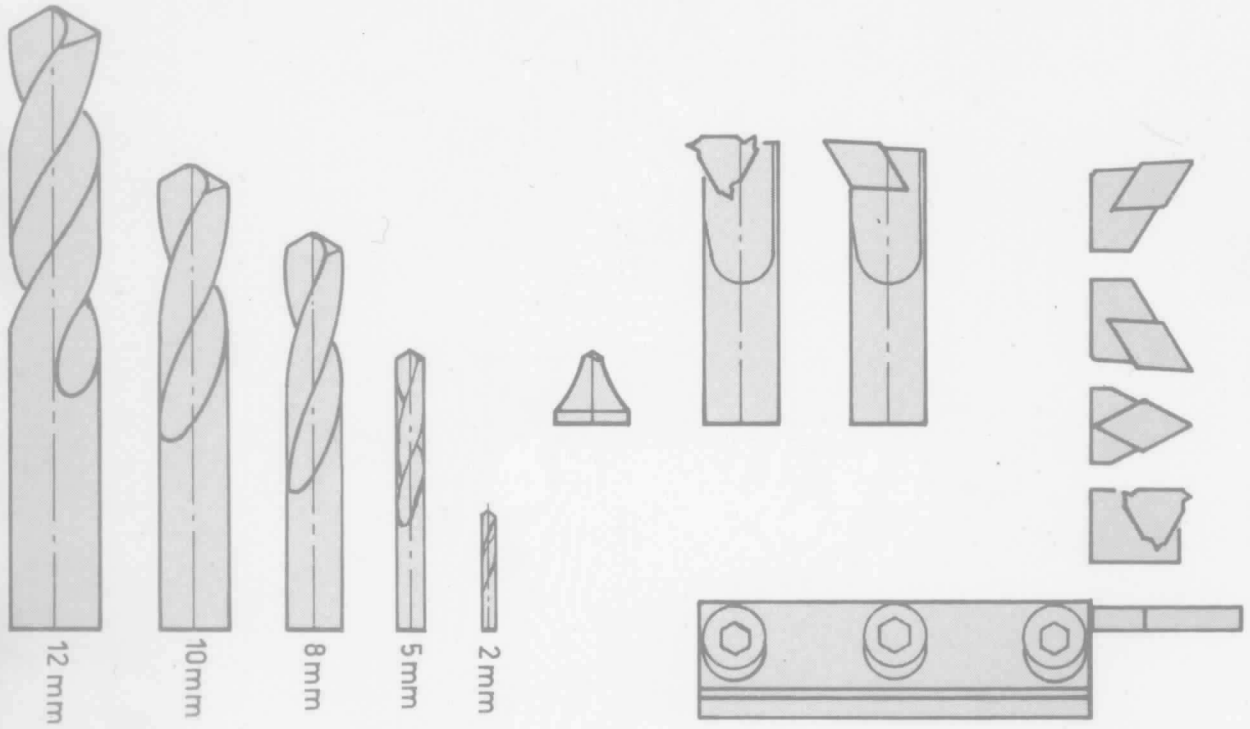
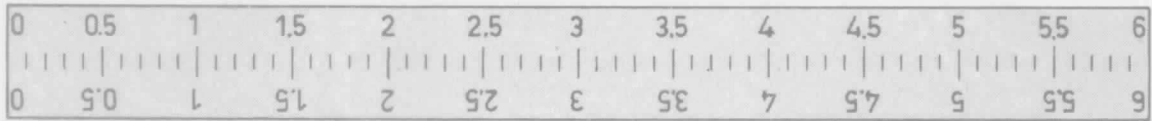
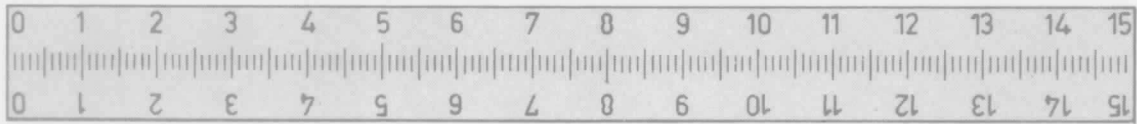

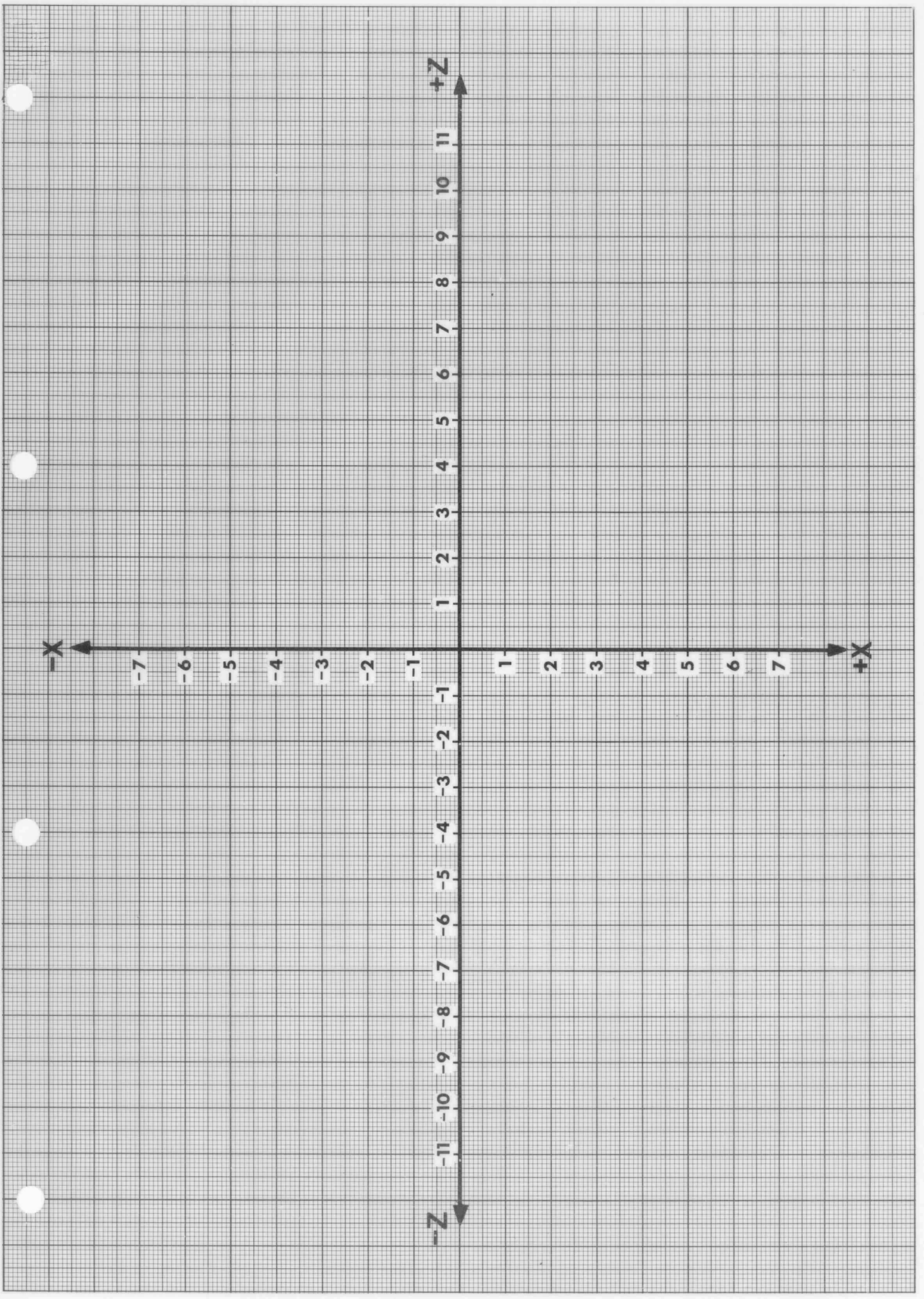

M 1:1



M 5:1

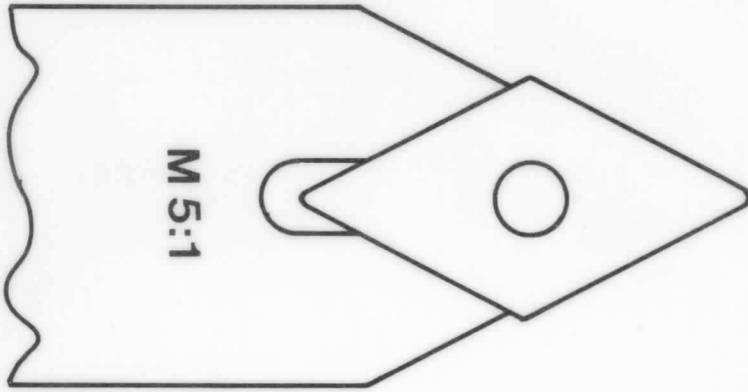

M 10:1

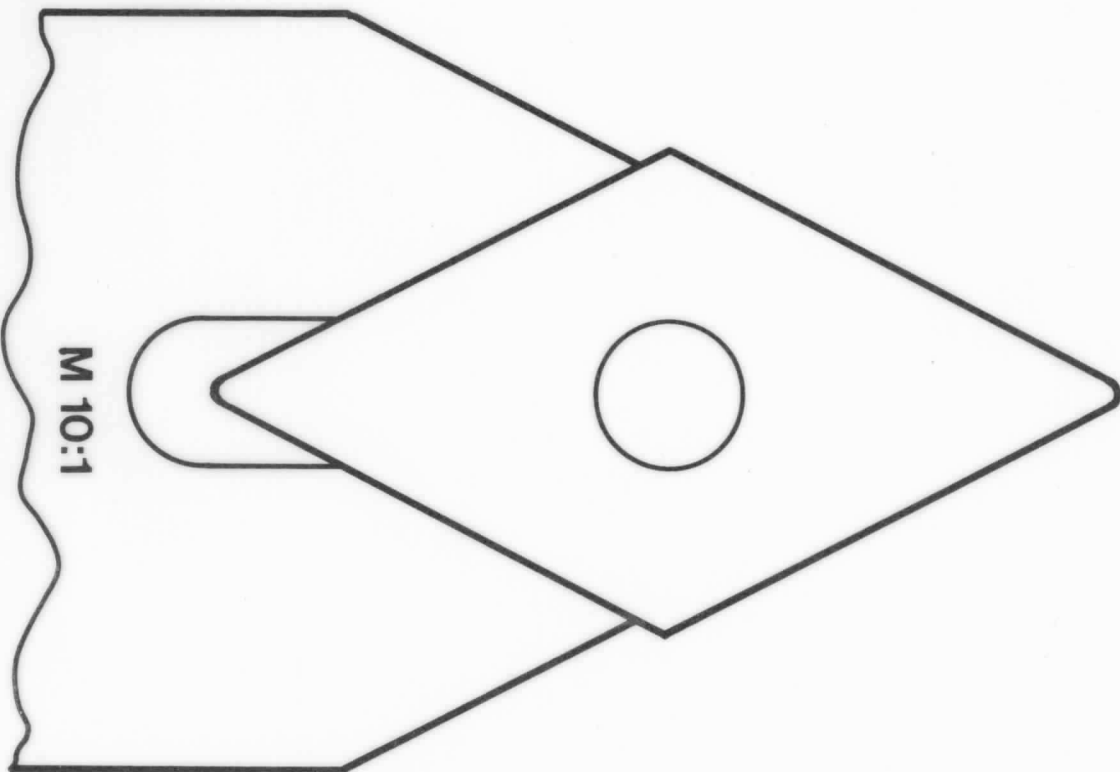



M 1:1

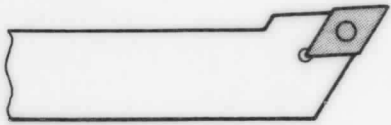

M 5:1

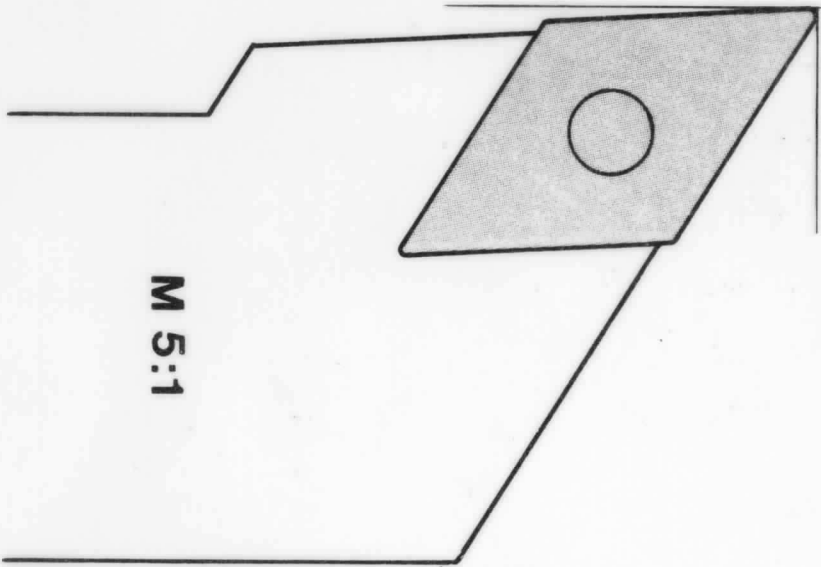

M 10:1

